

ST. MICHAEL
 MAUSOLEUM / SHELTER
 SEC. 4
 ALL SOULS CEMETERY

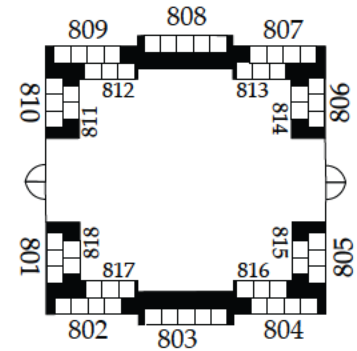

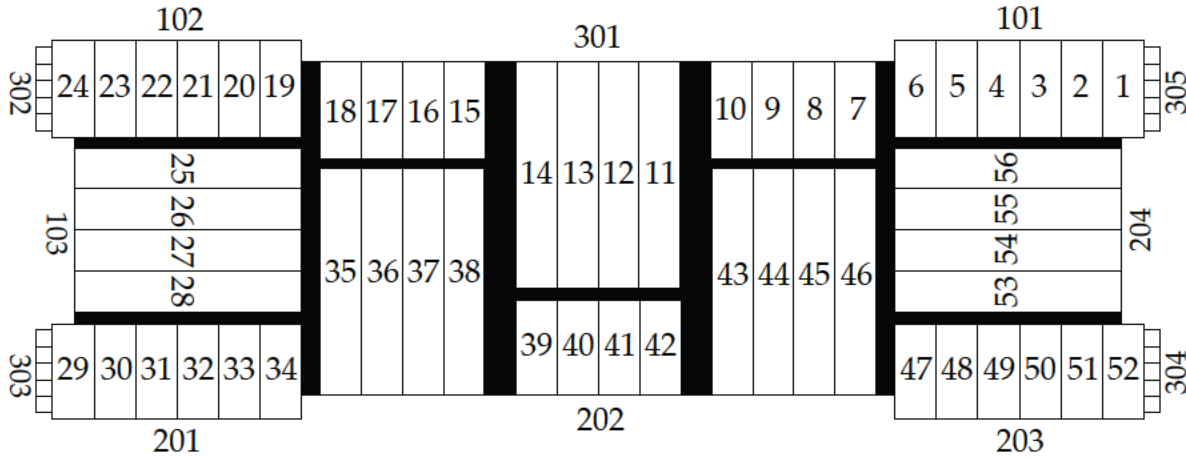
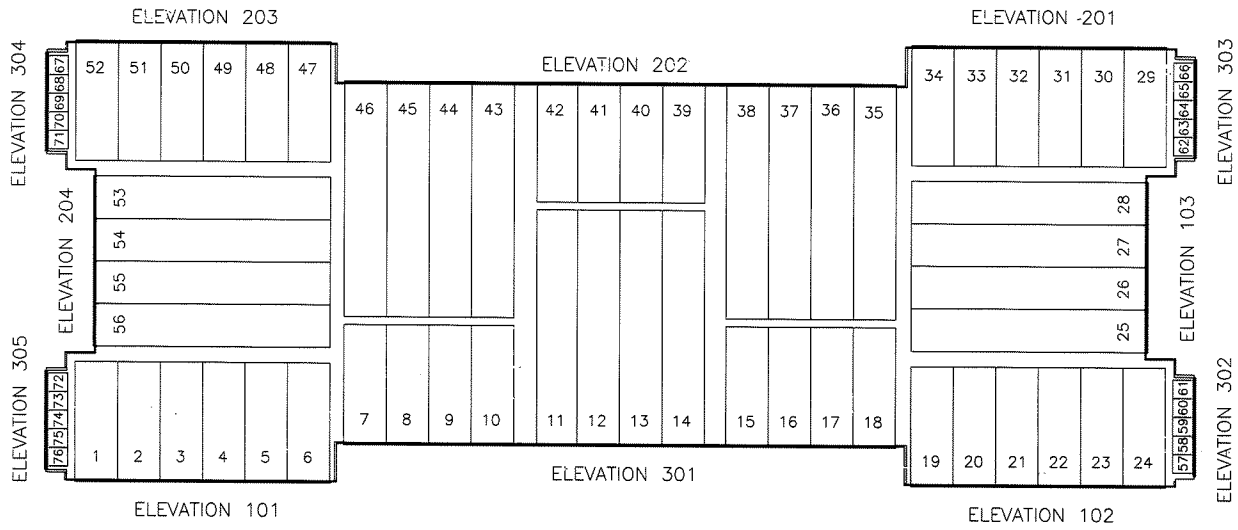

Note:
 All Crypts are designated and located by row number and tier letter.
 For example: Crypt 404 - A would be 404 and tier A.

A Designates Floor Level
 F Designates Ceiling Level

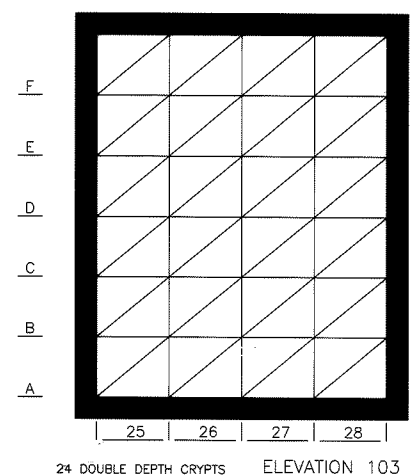
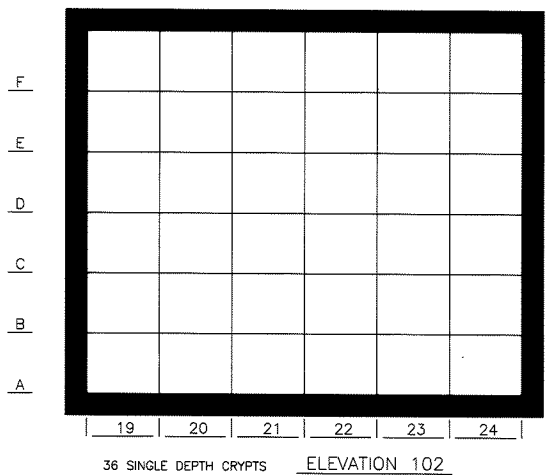
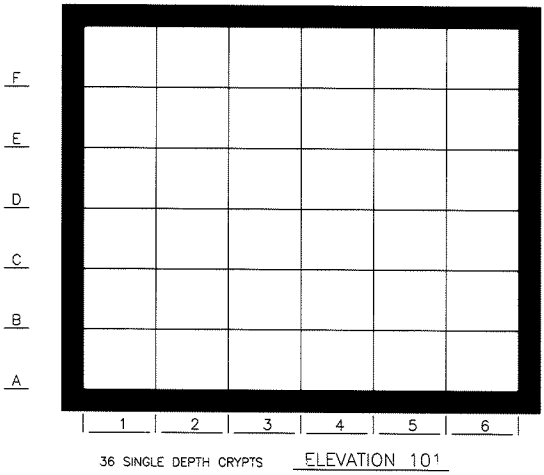

No.	DATE	REVISION
OFFICE OF DEVELOPMENT Catholic Cemeteries Association 10000 Miles Ave. Cleveland, Ohio 44105 216.641.7875 FAX: 216.641.0212		
Saint Michael the Archangel Mausoleum Section 4 All Souls Cemetery Catholic Cemeteries Association 10368 Chardon Road		
SHEET NAME:		
DATE:		
PROJECT No.: 082201-4		

M
L
K
J
I
H
G
F
E
D
C
B
A

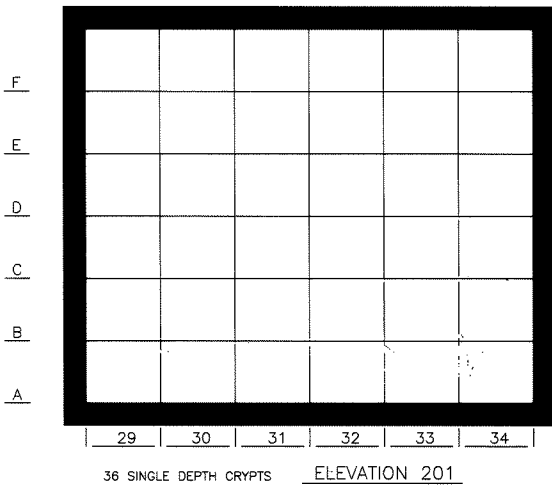

36 SINGLE DEPTH CRYPTS ELEVATION 201

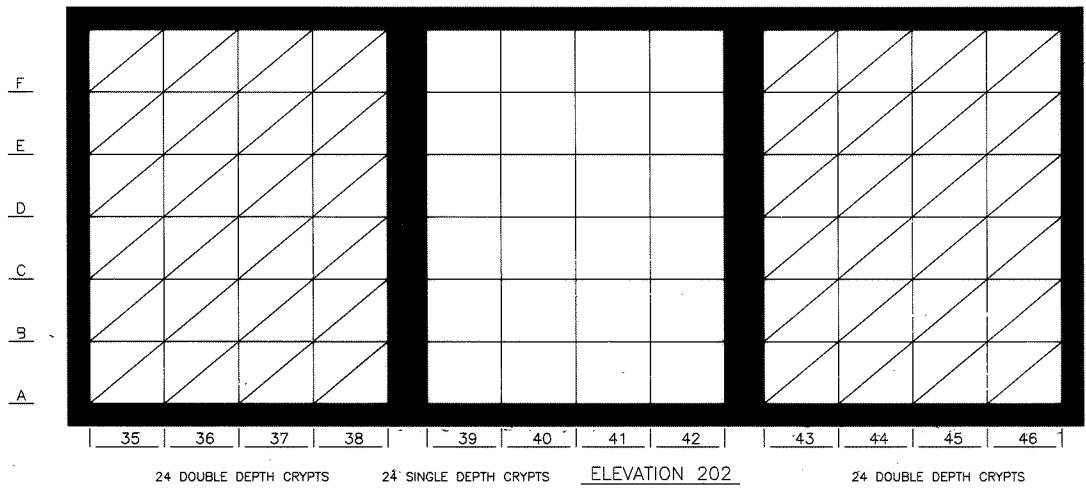

24 DOUBLE DEPTH CRYPTS 24 SINGLE DEPTH CRYPTS ELEVATION 202 24 DOUBLE DEPTH CRYPTS

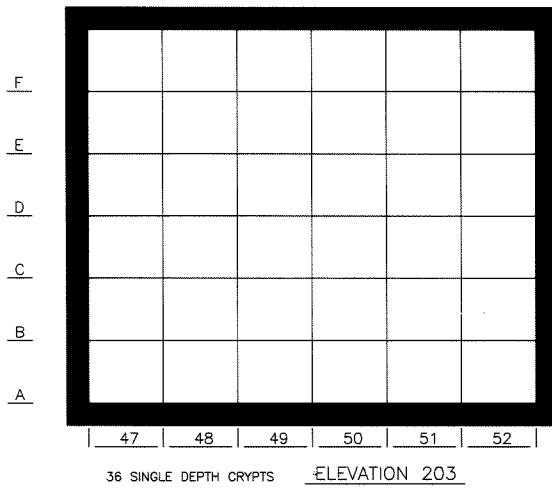

36 SINGLE DEPTH CRYPTS ELEVATION 203

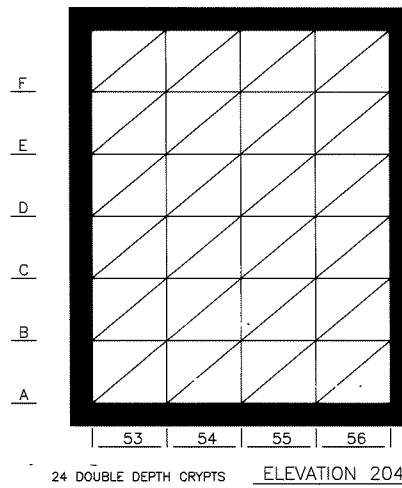

24 DOUBLE DEPTH CRYPTS ELEVATION 204

Note:
 All Crypts are designated and located by row number and tier letter. For example:
 Crypt 404 - A would be located in row 404 and tier A.

A Designates Floor Level
 F Designates Ceiling Level

No. DATE REVISION

OFFICE OF DEVELOPMENT?
 Catholic Cemetery Association
 1800 Miles Ave. Cleveland, Ohio
 44105
 216.841.7875
 FAX: 216.841.8212

Saint Michael the Archangel Mausoleum
Section 4
All Souls Cemetery
 Catholic Cemeteries Association
 10366 Chardon Road

SHEET NAME:

DATE:
 PROJECT No.:
 052201-4

M
L
K
J
I
H
G
F
E
D
C
B
A

1 2 3 4 5 6 7 8 9 10 11 12 13 14 15 16 17

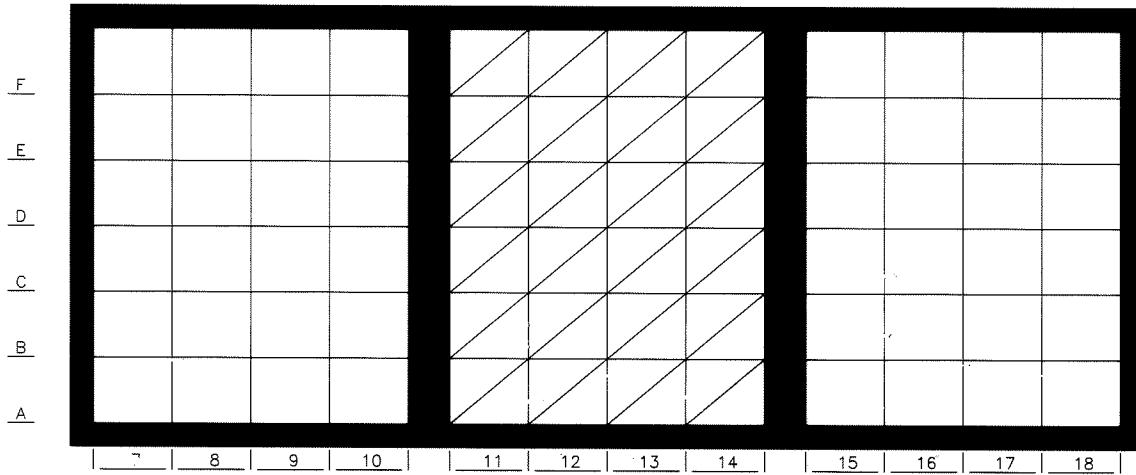

24 SINGLE DEPTH CRYPTS 24 DOUBLE DEPTH CRYPTS ELEVATION 301 24 SINGLE DEPTH CRYPTS

Note:
 All Crypts are designated and located by row number and tier letter. For example:
 Crypt 304 – A would be located in row 304 and tier A.

 A Designates Floor Level
 F Designates Ceiling Level

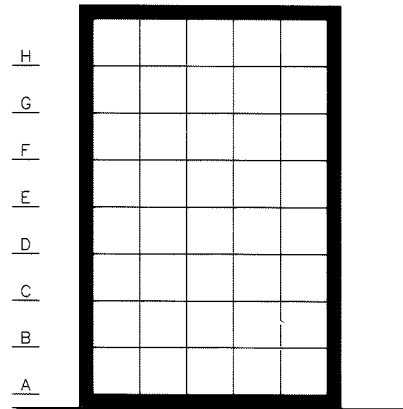

| 57 | 58 | 59 | 60 | 61 |
 40 UNIT NICHE CABINET
ELEVATION 302

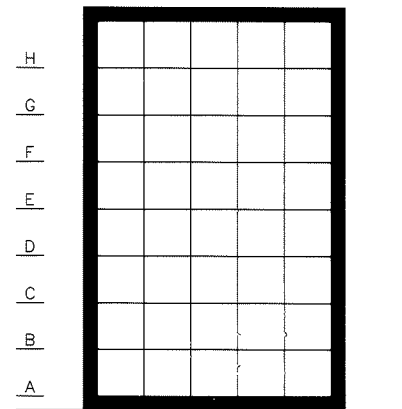

| 62 | 63 | 64 | 65 | 66 |
 40 UNIT NICHE CABINET
ELEVATION 303

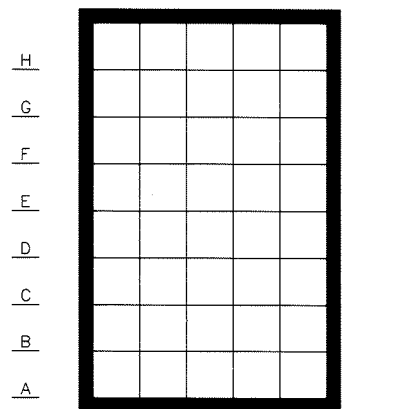

| 67 | 48 | 69 | 70 | 71 |
 40 UNIT NICHE CABINET
ELEVATION 304

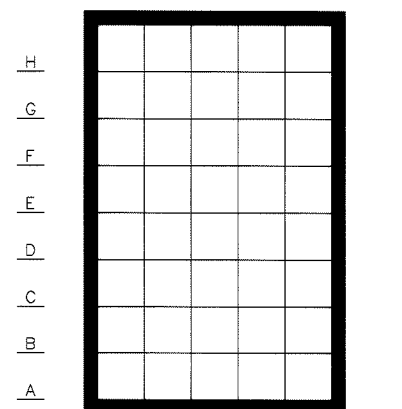

| 72 | 73 | 74 | 75 | 76 |
 40 UNIT NICHE CABINET
ELEVATION 305

No.	DATE	REVISION

OFFICE OF DEVELOPMENT
 Catholic Cemeteries Association
 4190 Miller Ave. Cleveland, Ohio
 216.841.7875
 FAX: 216.841.8212

Saint Michael the Archangel Mausoleum
Section 4
All Souls Cemetery
 Catholic Cemeteries Association
 10366 Chardon Road

SHEET NAME:

DATE:
 PROJECT No.:
 052201-4

M
L
K
J
I
H
G
F
E
D
C
B
A

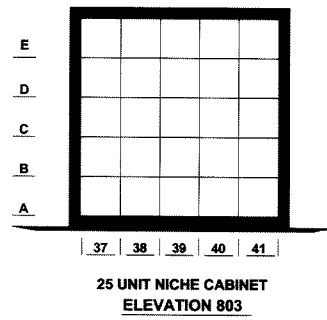
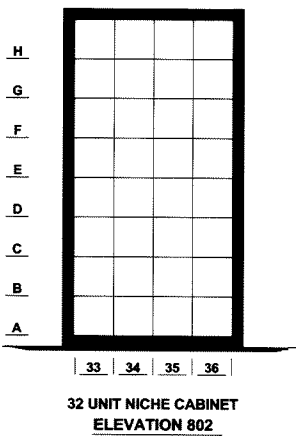
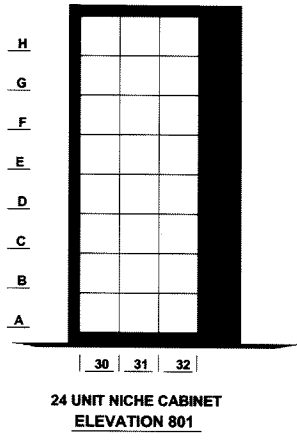
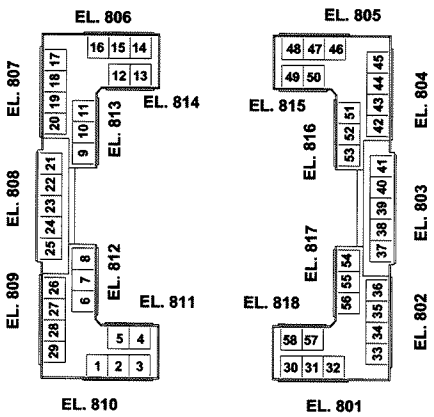

NOTE:
All niches are designated and located by row number and tier letter.
For example: Niche 36 - A would be located in row 36 and tier A.

Summary
217 Niches

A Designates Floor Level
F Designates Ceiling Level

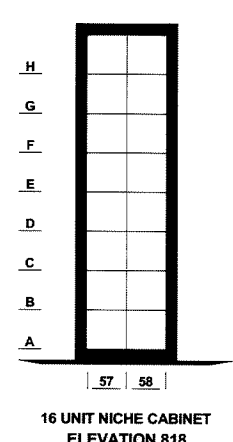
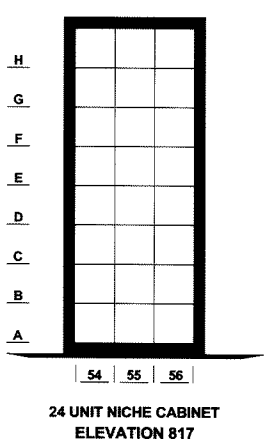
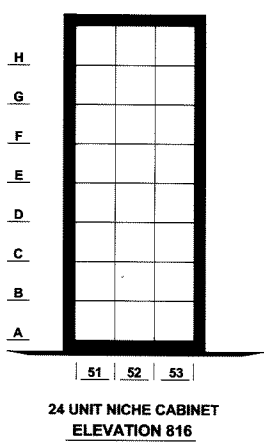
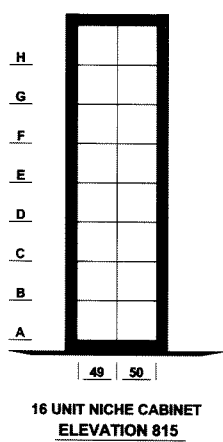
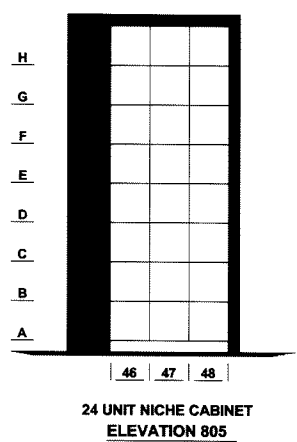
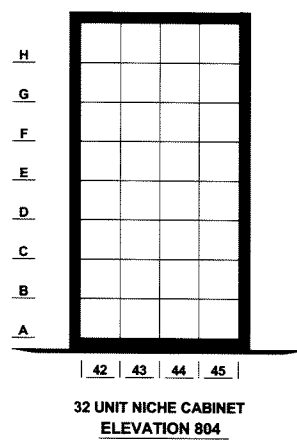

No.	DATE	REVISION	M
			L
No.	DATE	REVISION	K
			J
OFFICE OF DEVELOPMENT Catholic Cemeteries Association 10000 Miles Ave. Cleveland, Ohio 216.841.7575 FAX: 216.841.0212			I
Saint Michael the Archangel Mausoleum Section 4 All Souls Cemetery Catholic Cemeteries Association 10366 Chardon Road			H
SHEET NAME:			G
DATE:			F
PROJECT No.: 052201-4			E
			D
			C
			B
			A

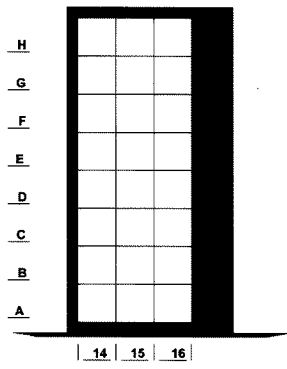
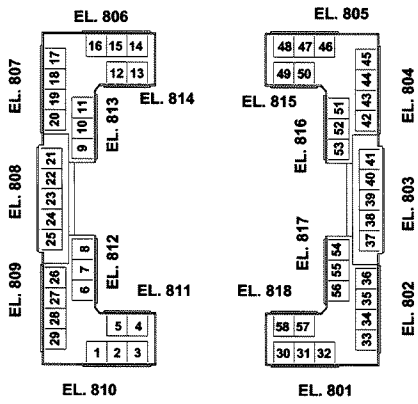

24 UNIT NICHE CABINET
ELEVATION 806

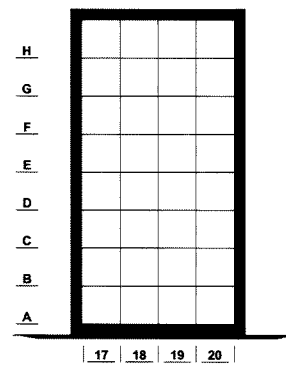

32 UNIT NICHE CABINET
ELEVATION 807

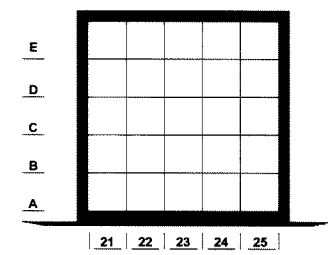

25 UNIT NICHE CABINET
ELEVATION 808

NOTE:
All niches are designated and located by row number and tier letter. For example: Niche 18 - A would be located in row 18 and tier A.

Summary
217 Niches

A Designates Floor Level
F Designates Ceiling Level

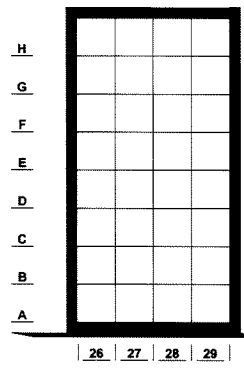

32 UNIT NICHE CABINET
ELEVATION 809

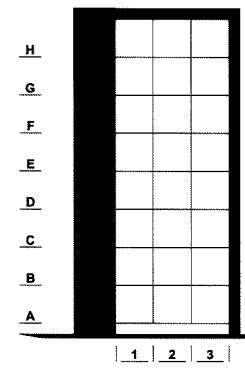

24 UNIT NICHE CABINET
ELEVATION 810

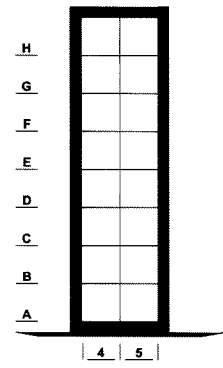

16 UNIT NICHE CABINET
ELEVATION 811

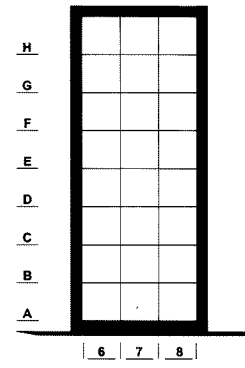

24 UNIT NICHE CABINET
ELEVATION 812

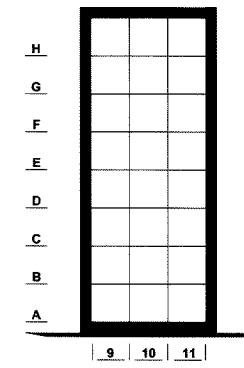

24 UNIT NICHE CABINET
ELEVATION 813

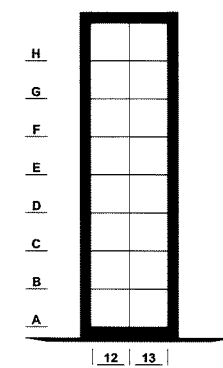

16 UNIT NICHE CABINET
ELEVATION 814

No.	DATE	REVISION	M
			L
			K
OFFICE OF DEVELOPMENT Catholic Cemeteries Association 10366 Miller Ave. Cleveland, Ohio 216.641.7575 FAX: 216.641.0212			J
Saint Michael the Archangel Mausoleum Section 4 All Souls Cemetery Catholic Cemeteries Association 10366 Chardon Road			I
SHEET NAME:			H
DATE:			G
PROJECT No.: 102501-4			F
			E
			D
			C
			B
			A